

NEW TX³ RANGE

TRUSTED PROTECTION
FOR YOUR INSTALLATIONS

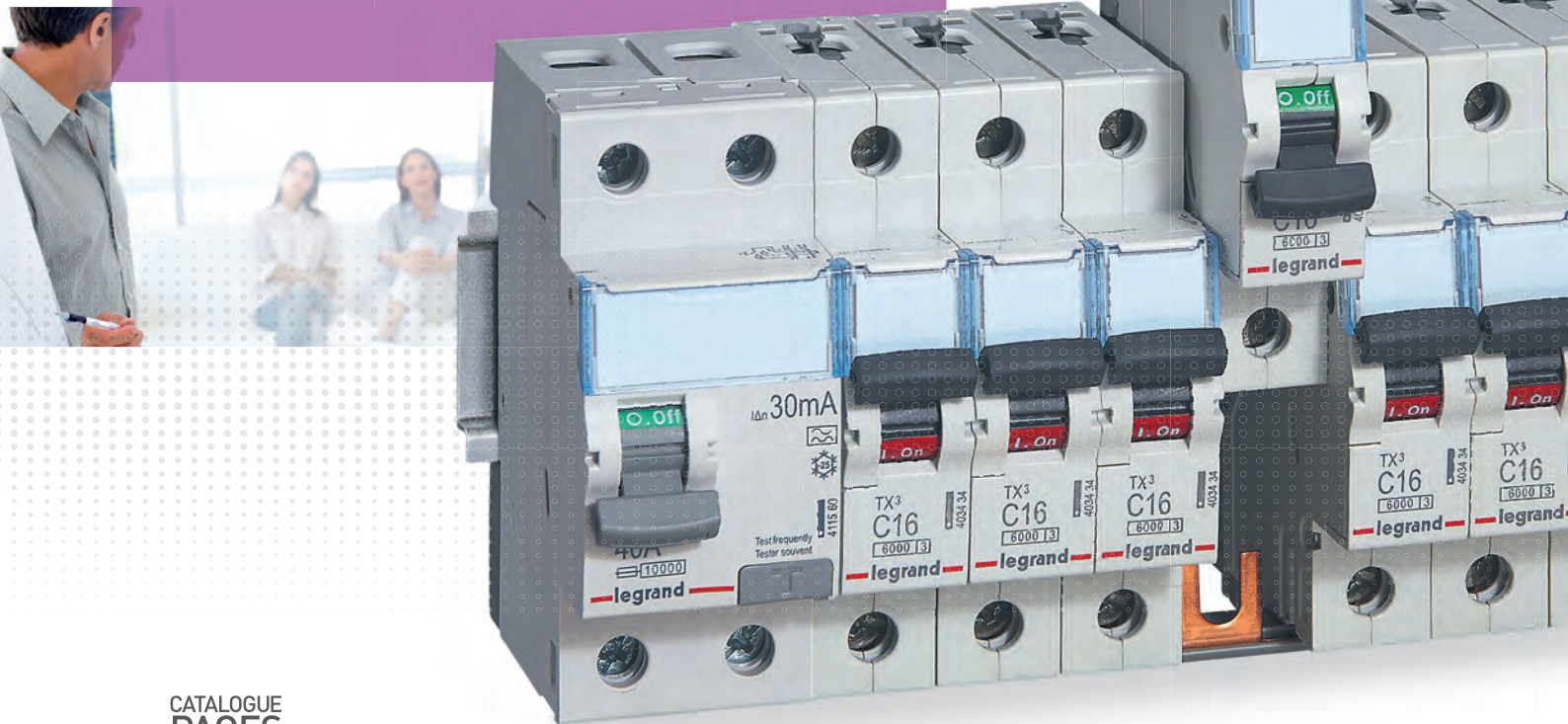

CATALOGUE
PAGES
INSIDE

GLOBAL SPECIALIST IN ELECTRICAL AND
DIGITAL BUILDING INFRASTRUCTURES

 **legrand**[®]

NEW TX³ RANGE PROTECTION YOU CAN RELY ON

Designed to meet the requirements of modern installations in residential and commercial applications, Legrand's new TX³ range provides effective protection against short-circuits, overloads and residual current faults. The range, which comprises thermal-magnetic circuit breakers and residual current devices and is complemented by numerous control and signalling auxiliaries, ensures safety, ruggedness and a high build quality for your installations.



RCCBs

- In = from 16 to 80 A
- 2P and 4P (neutral on right-hand side)
- Type AC and A
- Sensitivity: 30, 100, 300 mA
- Compliant with IEC 61008-1



THERMAL-MAGNETIC CIRCUIT BREAKERS

- $I_n = 2$ to 63 A
- 1P to 4P
- B and C curves
- Breaking capacity: 6000 A and 10000 A at 230/400V ~
- Compliant with IEC 60898-1



Common auxiliaries

Legrand offers a wide range of control and signalling auxiliaries common for all circuit breakers and RCCBs in the TX³ and DX³ ranges.

For more information, see p. 6

TX³ - SAFETY ON ALL LEVELS

The new TX³ range ensures safe installation and operation for maximum protection of people and property.



A PRODUCT DESIGNED WITH SAFETY IN MIND

The product design and materials have been carefully developed to allow air to flow freely between each device to avoid overheating.



WIRE GUIDE FLAP

Avoids connection errors for an increased safety level, by preventing insertion of the wire behind the terminal.

RELIABLE CONNECTIONS

Prong and fork type comb busbars guarantee connection quality by eliminating the risk of short-circuits and ensuring a reliable connection via the top or bottom of the device.

INCREASED SAFETY

IP 2x terminals - no direct contact with live parts, even with the faceplate open. Clamping screw for flat-blade or Pozidriv screwdriver. Reinforced terminals allowing tightening torques higher than those recommended by the standard.

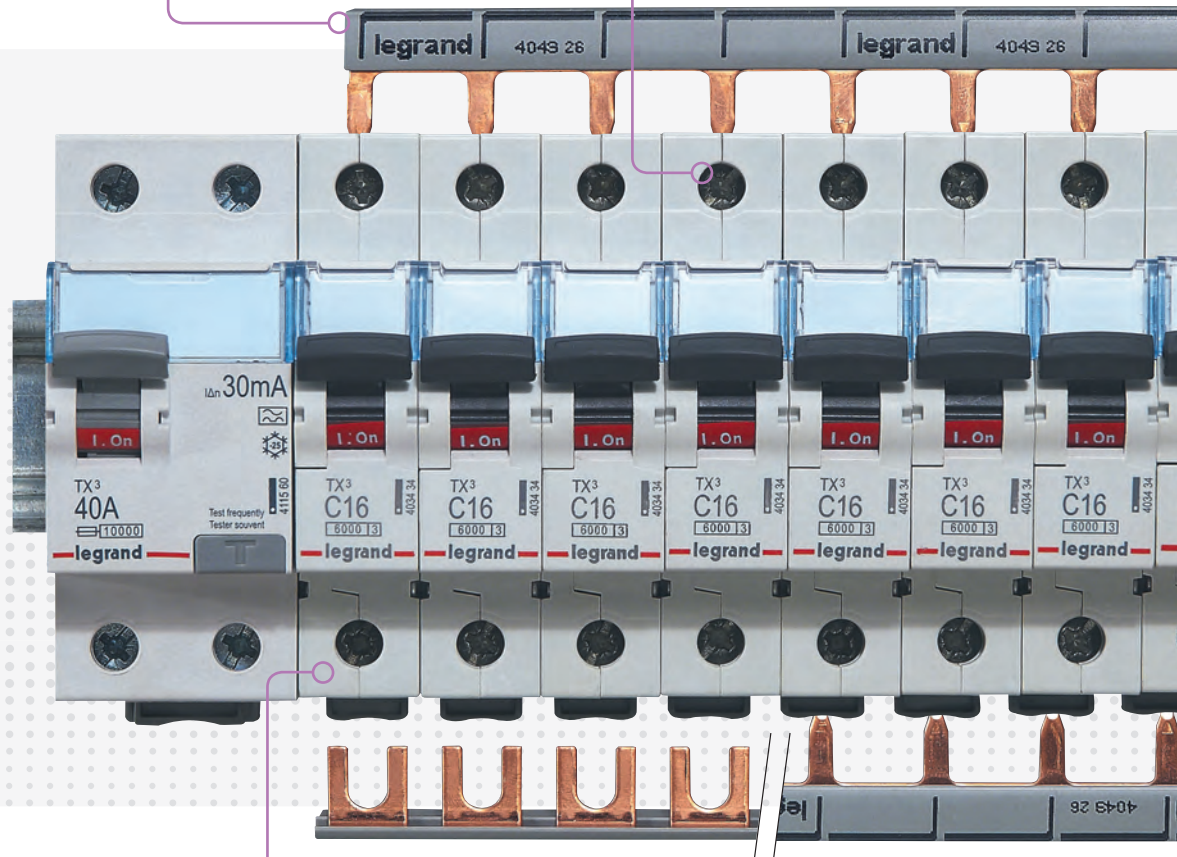

RISING CAGE CLAMP TERMINALS

The shape of the screws and terminals ensures excellent mechanical withstand of the wires and limits contact impedance, temperature rise and heat loss.



Bottom terminals compatible with fork or prong type comb busbars.



Limitation class 3

Circuit breakers with class 3 limitation provide excellent short-circuit protection. They limit the short-circuit energy released in cables and hence help to extend the service life of an installation.

TX³ - INSTALLATION AND MAINTENANCE MADE EASY

For ease of installation, wiring and maintenance, the new TX³ range has a number of features which help save time at each stage of a project.

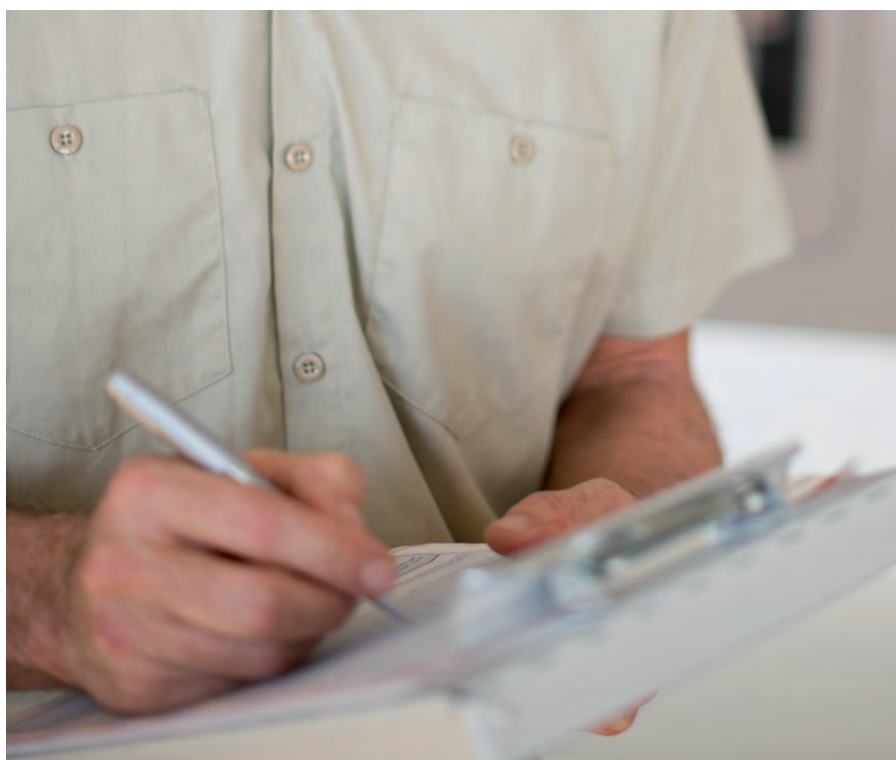

CLEAR MARKING ON THE FRONT PANEL

For quick visual identification of the relevant information - product name, curve type, rating, breaking capacity, limitation class.



TECHNICAL LABELLING AREA

For quick identification of each circuit according to the wiring diagram. The surface of this part of the modular devices has been specially treated to receive a temporary marking (adhesive label, felt pen or pencil).

ERGONOMIC LABEL HOLDER

For customisable labels. These holders provide effective, durable protection for the labels which are used to identify circuits clearly for the purposes of rapid intervention in the event of an error.

THE EXTRA-SPACE CLAMP

Ensures even more comfort during installation and allows independent MCB or RCCB removal with supply busbar in place (without removing the other devices on the same row).

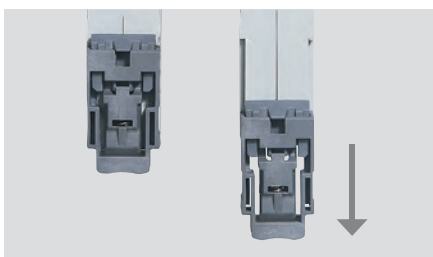
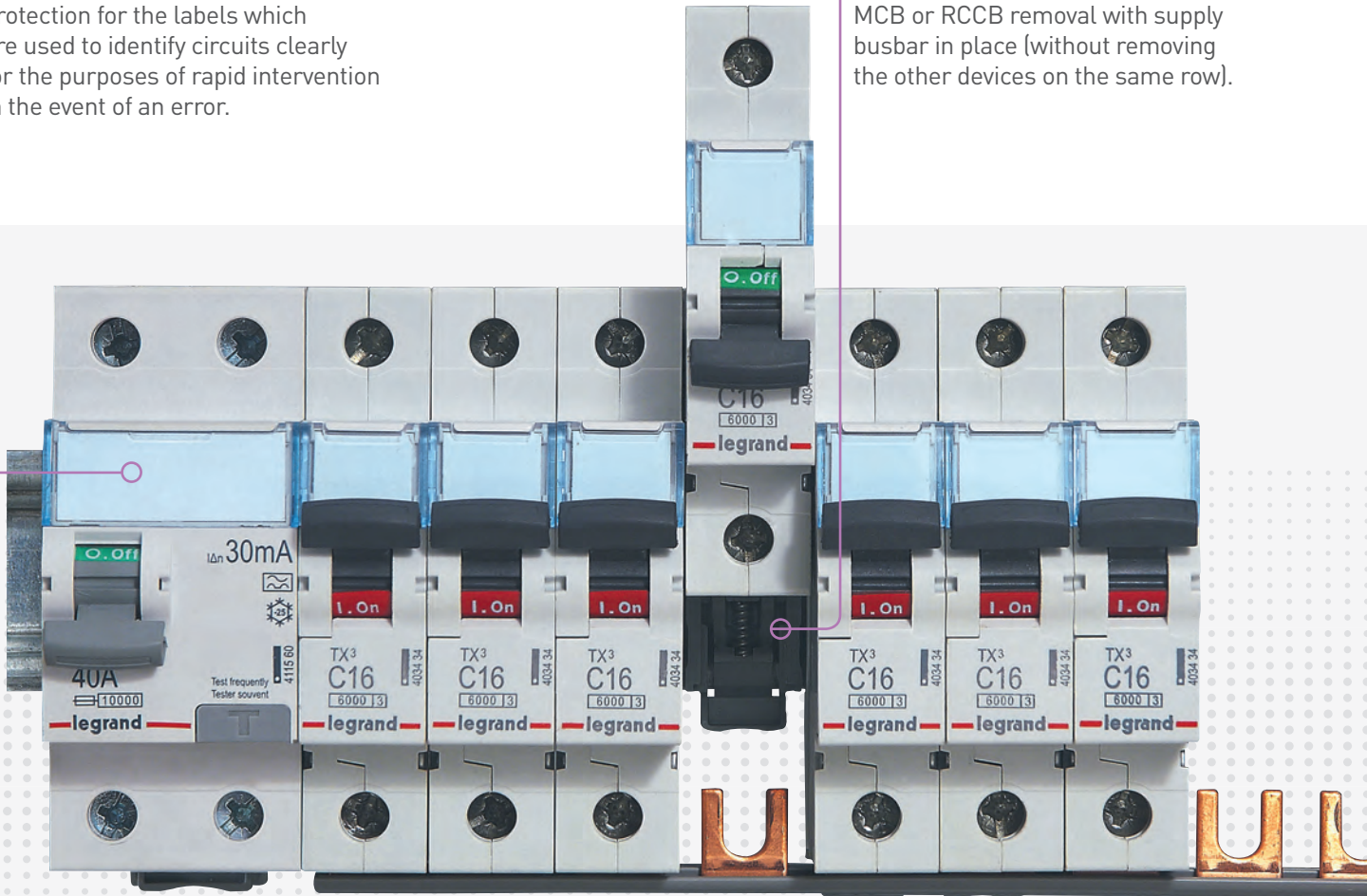

BISTABLE CLAMP

For easy positioning or removal of the product on the DIN rail. Compatible with flat-blade or pozidriv screwdrivers. Several additional functions of the DX³ range, such as isolating switches or single pole + neutral RCBOs, are also equipped with this clamp.



Quick visual identification of the function and contacts position

Black handle - circuit breaker
 Grey handle - RCCB
 I - ON marking and red : closed contacts
 O - OFF marking and green : open contacts

AUXILIARIES - OFFERING FLEXIBILITY FOR YOUR INSTALLATIONS

Legrand offers a wide range of control and signalling auxiliaries for TX³ circuit breakers and RCCBs to monitor and control circuits remotely. These auxiliaries are used for remote control and information feedback purposes in commercial premises and are also common to the DX³ range.



TOTAL FLEXIBILITY

Auxiliary contacts and fault signal contacts, shunt trips, undervoltage releases and motor-driven controls. Available in 0.5 or 1 module wide. The signalling auxiliaries exist in 2 versions, adapted for fork-type respectively prong-type supply busbars.

MARKINGS ON SIDE PANEL

Technical information, such as identification of the function, schematic, connection and mounting.

RETAINER CLIP

Auxiliaries are equipped with clips for quick, tool-free assembly which ensures a more robust unit.

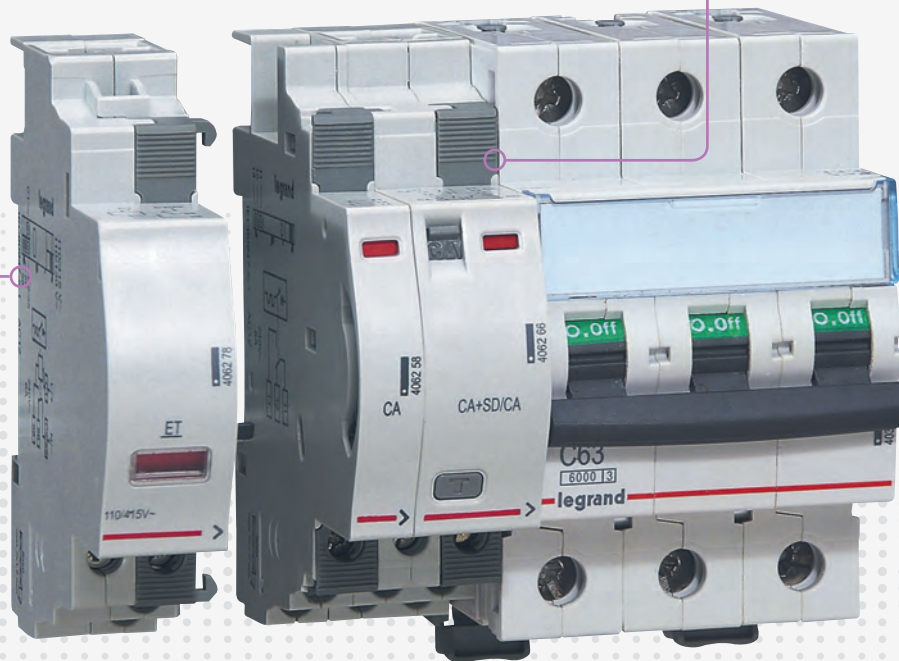
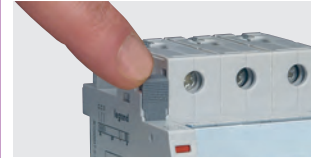

ACCESSIBLE TERMINALS

Visible, accessible screw heads make wiring easier.

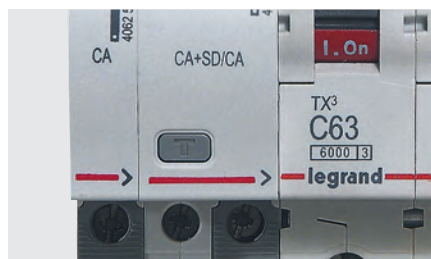

CLEAR MARKING

The arrow on the front of auxiliaries allows instant identification of the device to which they are associated.



Optimised space in the panel

Legrand (ON/OFF) motor-driven control is the most compact on the market at just **1 module wide**. These motor-driven controls are used with TX³ circuit breakers and RCCBs.

TX³ - HIGH BUILD QUALITY AND ENVIRONMENTALLY- FRIENDLY

At Legrand, we take pride in the quality of our products. The TX³ range has many approvals issued by independent certification bodies, renowned for their strict requirements.



Rugged reliability

10,000 operations with load
Electrical endurance

- 25°C to + 70°C
Extreme operating conditions



ECO-FRIENDLY

The TX³ range has been designed to comply with different environmental requirements such as the RoHS Directive.

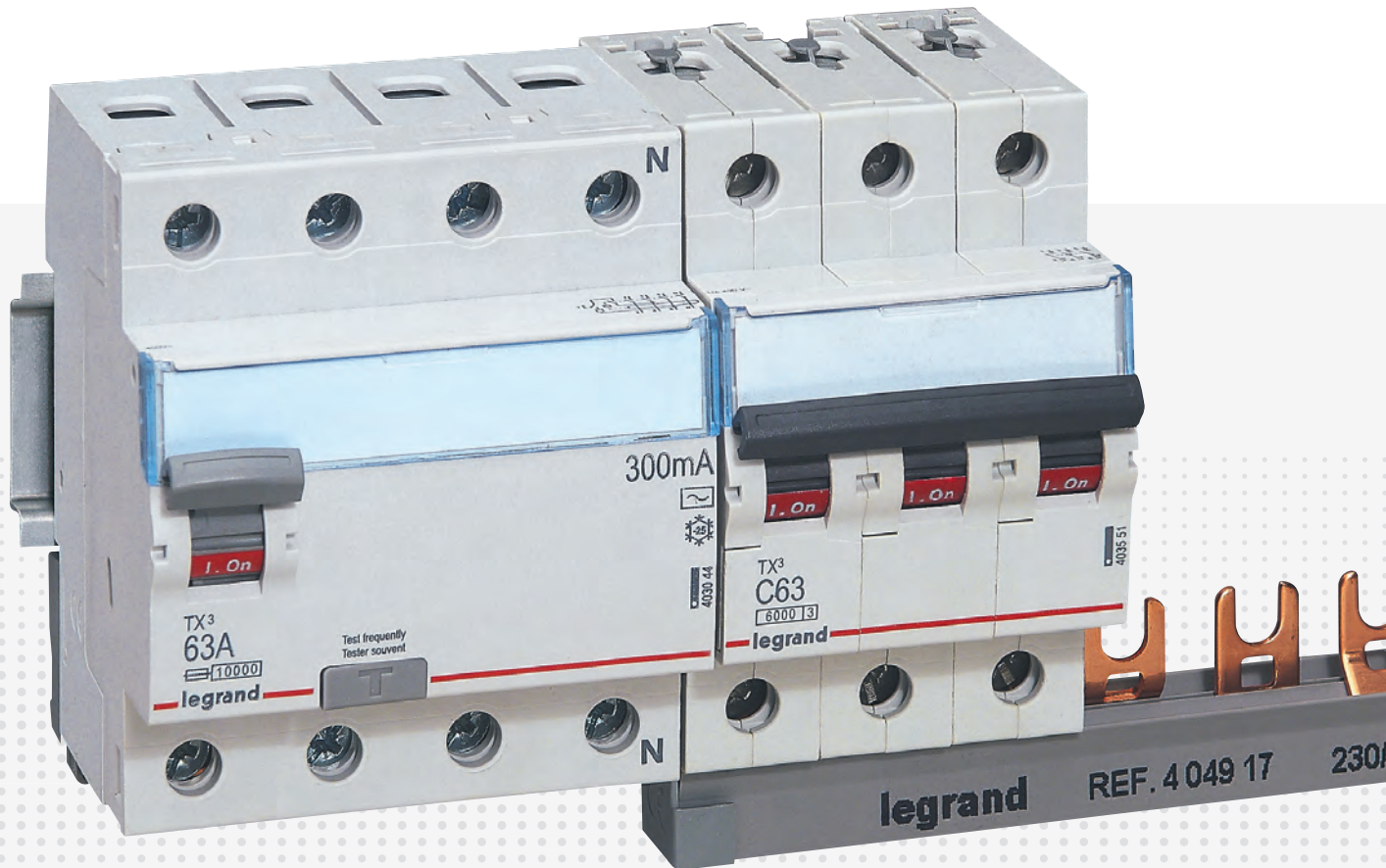

COPYTRACER - THE FIGHT AGAINST COUNTERFEITING

A unique serial number is printed on our circuit breakers which allows customers to check the authenticity of the product using the online Copytracer facility at www.legrand-copytracer.com.

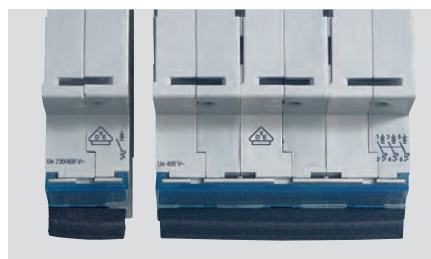

PRODUCTS CERTIFIED ACCORDING TO INTERNATIONAL STANDARDS



Rigorous, recognised approvals such as VDE (Germany) are renewed annually.



Certification of Legrand's production facilities

- ISO 9001 for quality
- ISO 14001 for environmental protection

MCBs TX³ 6000

thermal magnetic MCBs from 2 A to 63 A - B & C curve



Technical characteristics p. 14

Conform to IEC 60898-1
 Compatible with prong-type and fork type supply busbars
 Equipped with special DIN rail clamp allowing independent MCB removal with supply busbar in place
 Breaking capacity:
 [6000]- IEC 60898-1 - 230/400 V~
 6 kA - IEC 60947-2 - 230/400 V~
 Can be equipped with DX³ signalling and remote tripping auxiliaries and motorised controls (p. 12-13)
 Do not accept add-on modules

Pack	Cat.Nos		Single pole 230/400 V~	
	B curve	C curve	Nominal rating In (A)	Number of modules
10	4 033 50	4 034 27	2	1
10	4 033 53	4 034 30	6	1
10	4 033 55	4 034 32	10	1
10	4 033 56	4 034 33	13	1
10	4 033 57	4 034 34	16	1
10	4 033 58	4 034 35	20	1
10	4 033 59	4 034 36	25	1
10	4 033 60	4 034 37	32	1
10	4 033 61	4 034 38	40	1
10	4 033 62	4 034 39	50	1
10	4 033 63	4 034 40	63	1

Pack	Cat.Nos		2-pole 230/400 V~	
	B curve	C curve	Nominal rating In (A)	Number of modules
5	4 033 80	4 035 21	2	2
5	4 033 83	4 035 24	6	2
5	4 033 85	4 035 26	10	2
5	4 033 86	4 035 27	13	2
5	4 033 87	4 035 28	16	2
5	4 033 88	4 035 29	20	2
5	4 033 89	4 035 30	25	2
5	4 033 90	4 035 31	32	2
5	4 033 91	4 035 32	40	2
5	4 033 92	4 035 33	50	2
5	4 033 93	4 035 34	63	2

Pack	Cat.Nos		3-pole 400 V~	
	B curve	C curve	Nominal rating In (A)	Number of modules
1	4 033 95	4 035 38	2	3
1	4 033 98	4 035 41	6	3
1	4 034 00	4 035 43	10	3
1	4 034 01	4 035 44	13	3
1	4 034 02	4 035 45	16	3
1	4 034 03	4 035 46	20	3
1	4 034 04	4 035 47	25	3
1	4 034 05	4 035 48	32	3
1	4 034 06	4 035 49	40	3
1	4 034 07	4 035 50	50	3
1	4 034 08	4 035 51	63	3

Pack	Cat.Nos		4-pole 400 V~	
	B curve	C curve	Nominal rating In (A)	Number of modules
1	4 034 10	4 035 55	2	4
1	4 034 13	4 035 58	6	4
1	4 034 15	4 035 60	10	4
1	4 034 16	4 035 61	13	4
1	4 034 17	4 035 62	16	4
1	4 034 18	4 035 63	20	4
1	4 034 19	4 035 64	25	4
1	4 034 20	4 035 65	32	4
1	4 034 21	4 035 66	40	4
1	4 034 22	4 035 67	50	4
1	4 034 23	4 035 68	63	4

MCBs TX³ 10000

thermal magnetic MCBs from 2 A to 63 A - B & C curve



Technical characteristics p. 14

Conform to IEC 60898-1
 Compatible with prong-type and fork type supply busbars
 Equipped with special DIN rail clamp allowing independent MCB removal with supply busbar in place
 Breaking capacity:
 [10000]- IEC 60898-1 - 230/400 V~
 10 kA - IEC 60947-2 - 230/400 V~
 Can be equipped with DX³ signalling and remote tripping auxiliaries and motorised controls (p. 12-13)
 Do not accept add-on modules

Pack	Cat.Nos		Single pole 230/400 V~	
	B curve	C curve	Nominal rating In (A)	Number of modules
10	4 040 78	4 041 64	2	1
10	4 040 81	4 041 67	6	1
10	4 040 82	4 041 69	10	1
10	4 040 83	4 041 70	13	1
10	4 040 84	4 041 71	16	1
10	4 040 85	4 041 72	20	1
10	4 040 86	4 041 73	25	1
10	4 040 87	4 041 74	32	1
10	4 040 88	4 041 75	40	1
10	4 040 89	4 041 76	50	1
10	4 040 90	4 041 77	63	1

Pack	Cat.Nos		2-pole 230/400 V~	
	B curve	C curve	Nominal rating In (A)	Number of modules
5	4 041 06	4 041 98	2	2
5	4 041 09	4 042 01	6	2
5	4 041 10	4 042 03	10	2
5	4 041 11	4 042 04	13	2
5	4 041 12	4 042 05	16	2
5	4 041 13	4 042 06	20	2
5	4 041 14	4 042 07	25	2
5	4 041 15	4 042 08	32	2
5	4 041 16	4 042 09	40	2
5	4 041 17	4 042 10	50	2
5	4 041 18	4 042 11	63	2

Pack	Cat.Nos		3-pole 400 V~	
	B curve	C curve	Nominal rating In (A)	Number of modules
1	4 041 20	4 042 15	2	3
1	4 041 23	4 042 18	6	3
1	4 041 24	4 042 20	10	3
1	4 041 25	4 042 21	13	3
1	4 041 26	4 042 22	16	3
1	4 041 27	4 042 23	20	3
1	4 041 28	4 042 24	25	3
1	4 041 29	4 042 25	32	3
1	4 041 30	4 042 26	40	3
1	4 041 31	4 042 27	50	3
1	4 041 32	4 042 28	63	3

Pack	Cat.Nos		4-pole 400 V~	
	B curve	C curve	Nominal rating In (A)	Number of modules
1	4 041 48	4 042 49	6	4
1	4 041 51	4 042 52	6	4
1	4 041 52	4 042 54	10	4
1	4 041 53	4 042 55	13	4
1	4 041 54	4 042 56	16	4
1	4 041 55	4 042 57	20	4
1	4 041 56	4 042 58	25	4
1	4 041 57	4 042 59	32	4
1	4 041 58	4 042 60	40	4
1	4 041 59	4 042 61	50	4
1	4 041 60	4 042 62	63	4

RCCBs TX³ residual current circuit breakers

from 16 A to 80 A - AC and A types



4 115 10

4 117 09

Technical characteristics p. 14

Conform to IEC 61008-1. Equipped with special DIN clamp allowing independent RCCB removal with supply busbar in place

• AC type : detect AC component faults

• A type : detect AC and DC component faults

Can be equipped with DX³ signalling and remote tripping auxiliaries and motorised controls (p. 12-13)

Pack	Cat.Nos	2-pole - 230 V \sim		
		AC type		
		Sensitivity (mA)	In (A)	Number of modules
1	4 115 02	10	16	2
1	4 115 09	30	25	2
1	4 115 10	30	40	2
1	4 115 11	30	63	2
1	4 115 12	30	80	2
1	4 115 19	100	25	2
1	4 115 20	100	40	2
1	4 115 21	100	63	2
1	4 115 22	100	80	2
1	4 115 29	300	25	2
1	4 115 30	300	40	2
1	4 115 31	300	63	2
1	4 115 32	300	80	2
		A type		
1	4 115 52	10	16	2
1	4 115 59	30	25	2
1	4 115 60	30	40	2
1	4 115 61	30	63	2
1	4 115 62	30	80	2
1	4 115 64	100	25	2
1	4 115 65	100	40	2
1	4 115 66	100	63	2
1	4 115 67	100	80	2
1	4 115 74	300	25	2
1	4 115 75	300	40	2
1	4 115 76	300	63	2
1	4 115 77	300	80	2

Pack	Cat.Nos	4-pole 400 V \sim		
		Neutral on right-hand side		
		AC type		
		Sensitivity (mA)	In (A)	Number of modules
1	4 117 07	30	25	2
1	4 117 08	30	40	2
1	4 117 09	30	63	2
1	4 117 10	30	80	2
1	4 117 17	100	25	2
1	4 117 18	100	40	2
1	4 117 19	100	63	2
1	4 117 20	100	80	2
1	4 117 27	300	25	2
1	4 117 28	300	40	2
1	4 117 29	300	63	2
1	4 117 30	300	80	2
		A type		
1	4 117 64	30	25	2
1	4 117 65	30	40	2
1	4 117 66	30	63	2
1	4 117 67	30	80	2
1	4 117 74	100	25	2
1	4 117 75	100	40	2
1	4 117 76	100	63	2
1	4 117 77	100	80	2
1	4 117 84	300	25	2
1	4 117 85	300	40	2
1	4 117 86	300	63	2
1	4 117 87	300	80	2

AUXILIARIES AND REMOTE CONTROL

Common auxiliaries & remote control

The signalling and remote tripping auxiliaries and the motorised controls are common for DX³ MCBs, RCBs and TX³ MCBs and RCCBs. Signalling auxiliaries are available in two versions, adapted to the prong or fork type supply busbars.



1 module motorised controls p. 13

COMPACT SIZE

1 module motorised controls for remote tripping of 1-pole to 4-pole modular devices.



Auxiliaries p. 12

EASY TO INSTALL

Perfect fitting to protection devices
Easy access and visible terminals
Allow insertion of supply busbars



Power overvoltage protection p. 12
Motorised control with automatic resetting p. 13

AVAILABLE FUNCTIONS

- auxiliary or fault signal contact
- current shunt trips
- undervoltage releases
- power overvoltage protection
- motorised controls with or without automatic resetting

Signalling and remote tripping auxiliaries DX³



Technical characteristics p. 14

Pack	Cat.Nos	Signalling auxiliaries fork busbar adapted	Pack	Cat.Nos	Remote tripping auxiliaries
		To fit on the left-hand side of DX ³ and TX ³ devices Maximum number of auxiliaries per device: - 3 signalling auxiliaries or - 2 signalling auxiliaries + 1 remote tripping auxiliary Allow insertion of supply busbar, bottom side No tool required for joining together the auxiliary and the main device.			To fit on the left-hand side of DX ³ and TX ³ devices Maximum 1 remote tripping auxiliary per device Allow insertion of the supply busbar No tool required for joining together the auxiliary and the main device. For MCBs, RCBOs, RCCBs and remote trip isolating switches
1	4 062 50	Auxiliary contact 6 A - 250 V~ (changeover switch) For MCBs, RCBOs, RCCBs, isolating switch or remote trip isolating switch Indicates the position of the contacts of its associated device		1	Current shunt trips For remote tripping of its associated device via a N/O push button 12 to 48 V~/=
		Number of modules 0.5		1	110 to 415 V~
1	4 062 52	Fault signalling contact 6 A - 250 V~ (changeover switch) For MCBs, RCBOs, RCCBs, Indicates the fault tripping of its associated device		1	Undervoltage releases For remote tripping of its associated device in case of mains voltage drop down or with the help of a N/C push button 24 to 48 V~/=
		Number of modules 0.5		1	230 V~
1	4 062 56	Auxiliary or fault signalling contact 6 A - 250 V~ (changeover switch) For MCBs, RCBOs, RCCBs Allows the choice between the two functions		1	Power overvoltage protection (POP) Protects the circuit by tripping its associated device in case of overvoltage between phase and neutral. Tripping threshold : 275 V (eg. in case of neutral failure)
		Number of modules 0.5		1	
1	4 062 64	Auxiliary + fault signalling contact or auxiliary contact + auxiliary contact 6 A - 250 V~ (changeover switch) For MCB, RCBOs, RCCBs		1	Autonomous shunt trip for N/C push-button 230 V~ For remote tripping with positive security on a control circuit via a N/C push-button or emergency stop. Does not trigger its associated device in case of mains power failure (the trigger occurs only after a deliberate action of a N/C push-button). Supplied with battery Minimum working reserve : 60 hours (for remote tripping even if there is no supply voltage)
		Number of modules 1		1	Spare battery for autonomous shunt trip Cat.No 4 062 87
					1.5
		Signalling auxiliaries prong busbar adapted To fit on the left-hand side of DX ³ and TX ³ devices Maximum number of auxiliaries per device: - 3 signalling auxiliaries or - 2 signalling auxiliaries + 1 remote tripping auxiliary Allow insertion of the supply busbar, top side No tool required for joining together the auxiliary and the main device.			
1	4 062 58	Auxiliary contact 6 A - 250 V~ (changeover switch) For MCBs, RCBOs, RCCBs, isolating switches or remote trip isolating switches Indicates the position of the contacts of its associated device.		1	4 062 85
		Number of modules 0.5			
1	4 062 60	Fault signalling contact 6 A - 250 V~ (changeover switch) For MCBs, RCBOs, RCCBs, Indicates the fault tripping of its associated device			
		Number of modules 0.5			
1	4 062 62	Auxiliary or fault signalling contact 6 A - 250 V~ (changeover switch) For MCBs, RCBOs, RCCBs Allows the choice between the two functions			
		Number of modules 0.5			
1	4 062 66	Auxiliary + fault signalling contact or auxiliary contact + auxiliary contact 6 A - 250 V~ (changeover switch) For MCBs, RCBOs, RCCBs			
		Number of modules 1			

Motorised controls DX³, STOP&GO automatic resetting



DX³ and accessories

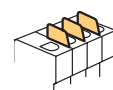

Pack	Cat.Nos	Motorised controls
		For remote control (opening and closing) of their associated device. To fit on the left-hand side of DX ³ and TX ³ devices For MCBs, RCBOs, RCCBs and remote trip isolating switches (from 1P to 4P) Can take one control auxiliary and one signalling auxiliary. No tool required for joining together the motorised control and the main device
1	4 062 90	ON/OFF function - for 1 module / pole devices (In up to 63 A)
1	4 062 91	Control voltage 24-48 V \sim /= Number of modules 230 V \sim 1
1	4 062 92	ON/OFF function - for 1.5 module / pole devices (In up to 125 A) 230 V \sim 1
		ON/OFF + automatic resetting function - for 1 module / pole devices (In up to 63 A) Automatically resets the device to which it is associated, thus ensuring continuity of service
1	4 062 93	Control voltage 24-48 V \sim /= No. of modules 230 V \sim 2
1	4 062 95	230 V \sim 2
		STOP&GO automatic resetting For automatic resetting of 1 module per pole RCCBs and RCBOs up to 63 A STOP&GO is used in the event of unwanted tripping generated by temporarily electrical disturbances or other external events. Can take one control auxiliary and one signalling auxiliary. The signalling auxiliary must be placed between the STOP&GO and the control auxiliary. No tool required for assembling
1	4 062 88	Automatic resetting function Control voltage 230 V \sim No. of modules 230 V \sim 2
1	4 062 89	Automatic resetting + periodic self-test function 230 V \sim 2

Pack	Cat.Nos	Manual supply inverter (MSI)
		For manually switching between the mains and an alternative power supply. Allow to restore power on pre-designated and/or critical circuits in case of a power failure of the main supply. For DX ³ MCBs and remote trip isolating switches Installation principle - see e-catalogue
1	4 063 14	For 2P 2-module devices
1	4 063 15	For 3P 3-module devices
1	4 063 16	For 4P 4-module devices
		Front external rotary handles Allow the manual control (open/close) of a modular device without opening the enclosure For all DX ³ , TX ³ and RX ³ devices from 2P upwards Supplied with bracket, connection rod, handle, self-adhesive drilling template and connection accessories Installation principle - see e-catalogue
1	4 063 19	Black handle
1	4 063 20	Yellow and red handle
		Wiring management accessories
		Insulating shields For 1 module per pole MCBs For separation between the terminals of the MCB, when using high cross section cables
1	4 063 05	
10	4 063 07	Spacing unit with feedthrough 0.5 module Allows cables to run between two modular devices and creates an air channel in order to limit temperature rise
		Terminals for aluminium cables
1	4 063 10	For 1.5 module/pole MCBs up to 63 A
1	4 063 11	For 1.5 module/pole MCBs and remote trip isolating switches from 80 A to 125 A
		Safety and maintenance accessories
		Sealable screw covers
2	4 063 04	For 1 module per pole MCBs (set of 4)
1	4 063 12	For 1.5 module per pole MCBs (set of 4)
		Terminal shield
1	4 063 06	For 1.5 module/pole MCBs (set of 2)
		Padlocking To lock the handle of a modular device during maintenance
1	0 227 97	Large padlock, Ø6 mm, 50 mm length Supplied with two keys and labels
3	4 063 13	Small padlock, Ø5 mm
2	4 063 03	Support for one padlock (for small or large model) For locking the handle of the modular devices (MCBs, RCCBs, RCBOs or isolating switches) in OFF position

Breaking capacity in IT neutral earthing system

MCB single pole breaking capacity at 400 V according to IEC 60947-2

TX ³ 6000 6 kA	1P/2P/3P/4P	3 kA
TX ³ 10000 10 kA	1P/2P/3P/4P	4 kA

Breaking capacity in the event of short-circuit to earth and insulation voltage

	1P/2P/3P/4P 230/400 V~ MCBs	
	TX ³ 6000 6 kA	TX ³ 10000 10 kA
I _{cn1}	6000 A	10000 A
U _i	500 V	500 V

I_{cn1}: Breaking capacity on 1 pole for multipole MCBs in the event of short-circuit to earth
 U_i: Rated insulation voltage

Terminal connection cross-sections (mm²)

Copper cable	Rigid		Flexible
	TX ³ 6000 6 kA	35	25
TX ³ 10000 10 kA			
Auxiliaries	2.5	2.5	

MCB tripping curves

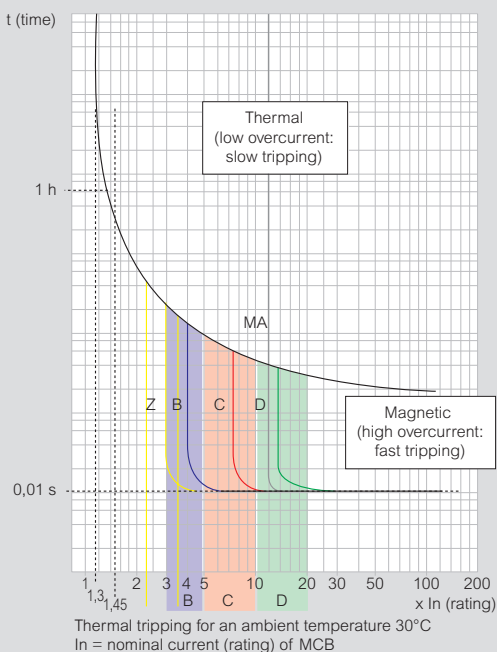

Curves	Magnetic threshold settings
Z ⁽¹⁾	2.4 to 3.6 I _n
B	3 to 5 I _n
C	5 to 10 I _n
D	10 to 14 I _n (10 to 20 acc. to the stds)
MA ⁽¹⁾	12 to 14 I _n

1: On request

Performance of RCCBs

AC type - Standard applications

Detection of 50-60 Hz AC residual currents

A type - Specific applications: dedicated lines

In addition to the characteristics of AC type add-on modules, A type add-on modules also detect residual currents with DC components. They are used whenever the fault currents are not sinusoidal. They are particularly suitable for the following dedicated line applications:

- On circuits where class 1 equipment may produce fault currents with DC components, such as variable speed drives with frequency inverter, etc.

Average residual current performance curves

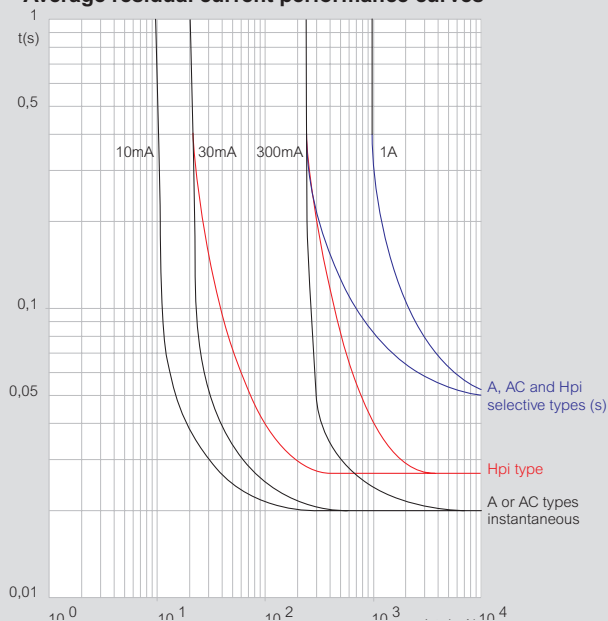

Technical characteristics of auxiliaries

Max. connection cross-section: 2.5 mm²
 Operating temperature: - 25°C to + 70°C

Shunt trips

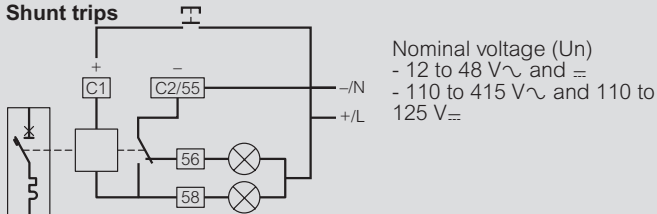

Nominal voltage (Un)
 - 12 to 48 V \sim and \equiv
 - 110 to 415 V \sim and 110 to 125 V \equiv

Equipped with a signalling contact which indicates tripping of the shunt trip and automatically breaks the coil.
 Min. and max. voltage: 0.7 to 1.1 Un
 Tripping time: less than 20 ms
 Power consumption: at 1.1 x 48 V = 121 VA
 at 1.1 x 415 V = 127 VA
 Impedance: 12 to 48 V = 23 Ω
 110 to 415 V = 1640 Ω

Consumption	Umin.	Umax.
12 to 48 V	522 mA	2610 mA
110 to 415 V	69 mA	259 mA

Undervoltage releases

Pull-in voltage $\geq 0.55 U_n$
 Tripping time: 100 to 400 ms \pm 10% (adjustable)
 Power consumption: 24 V \sim and \equiv : 0.1 VA
 48 V \sim and \equiv : 0.2 VA
 230 V \sim : 1 VA

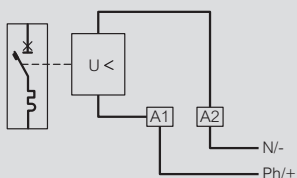

Nominal voltage:
 24 and 48 V \sim and \equiv
 230 V \sim

Stand-alone releases for N/C push-buttons

Min. and max. operating voltage: 196 to 250 V \sim
 Power consumption: 1.4 VA

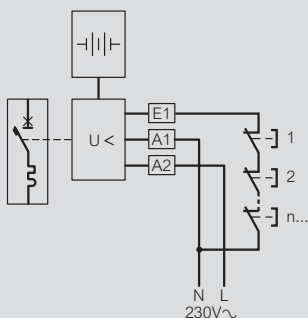

Signalling auxiliaries

Umin.: 24 V \sim/\equiv and Imin.: 5 mA

Technical characteristics of auxiliaries (continued)

Max. connection cross-section: 2.5 mm²
 Operating temperature: - 25°C to + 70°C

Power overvoltage protection (POP)

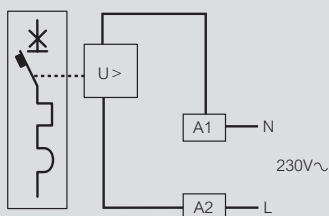

Conform to EN 50550:2010
 Mechanical indicator on the front panel:
 - red indicator : tripping on a fault (overvoltage)
 - transparent window : the power overvoltage protection is ON (armed position)
 Power consumption: 0.45 VA at 230 V \sim

	Voltage Ua				
	255 V	275 V	300 V	350 V	400 V
Maximum actuation time (s)	No tripping				
Maximum non activating time (s)	3	1	0.25	0.7	

Compatibility between auxiliaries on 1 module/pole devices

1 module / pole device (auxiliary on the left side)	1st auxiliary	2nd auxiliary	3rd auxiliary
1st auxiliary	4 062 .. 50/52/56/58/60/ 62/66/76/78/80/ 82/84/86/87	-	-
2nd auxiliary	4 062 .. 50/52/56/ 58/60/62	4 062 .. 50/52/56/58/60/62/76/ 78/80/82/84/86/87	-
	4 062 .. 64/66/	4 062 .. 50/52/56/58/60/62/64/ 66/76/78/80/82/84/86/87	-
3rd auxiliary	4 062 .. 50/52/56/ 58/60/62	4 062 .. 50/52/56/58/60/62	4 062 .. 76/78/80/82/ 84/86/87
	4 062 .. 64/66	4 062 .. 50/52/56/58/ 60/62/64/66	

Catalogue number index

Cat.Nos	Page N°	Pack	Cat.Nos	Page N°	Pack	Cat.Nos	Page N°	Pack	Cat.Nos	Page N°	Pack	Cat.Nos	Page N°	Pack	Cat.Nos	Page N°	Pack
0 227 00			4 034 19	10	1	4 035 67	10	1	4 041 58	10	1	4 062 00			4 115 21	11	1
0 227 97	13	1	20	10	1	68	10	1	59	10	1				22	11	1
4 033 00			21	10	1	4 040 00			60	10	1				29	11	1
4 033 50	10	10	22	10	1				64	10	10	4 062 50	12	1	30	11	1
53	10	10	23	10	1				67	10	10	52	12	1	31	11	1
55	10	10	27	10	10				69	10	10	56	12	1	32	11	1
56	10	10	30	10	10	4 040 78	10	10	70	10	10	58	12	1	52	11	1
57	10	10	32	10	10	81	10	10	71	10	10	60	12	1	59	11	1
58	10	10	33	10	10	82	10	10	72	10	10	62	12	1	60	11	1
59	10	10	34	10	10	83	10	10	73	10	10	64	12	1	61	11	1
60	10	10	35	10	10	84	10	10	74	10	10	66	12	1	62	11	1
61	10	10	36	10	10	85	10	10	75	10	10	76	12	1	64	11	1
62	10	10	37	10	10	86	10	10	76	10	10	78	12	1	65	11	1
63	10	10	38	10	10	87	10	10	77	10	10	80	12	1	66	11	1
80	10	5	39	10	10	88	10	10	98	10	5	82	12	1	67	11	1
83	10	5	40	10	10	89	10	10	4 042 00			85	12	1	74	11	1
85	10	5	4 035 00			90	10	10	4 042 01	10	5	86	12	1	75	11	1
86	10	5	4 035 21	10	5	4 041 00			03	10	5	87	12	1	76	11	1
87	10	5	24	10	5	4 041 06	10	5	04	10	5	88	13	1	77	11	1
88	10	5	26	10	5	09	10	5	05	10	5	89	13	1	4 117 00		
89	10	5	27	10	5	10	10	5	06	10	5	90	13	1	4 117 07	11	1
90	10	5	28	10	5	11	10	5	07	10	5	91	13	1	08	11	1
91	10	5	29	10	5	12	10	5	08	10	5	92	13	1	09	11	1
92	10	5	30	10	5	13	10	5	09	10	5	93	13	1	10	11	1
93	10	5	31	10	5	14	10	5	10	10	5	94	13	1	17	11	1
95	10	1	32	10	5	15	10	5	11	10	5	95	13	1	18	11	1
98	10	1	33	10	5	16	10	5	15	10	1	4 063 00			19	11	1
4 034 00			34	10	5	17	10	5	18	10	1	4 063 03	13	2	20	11	1
4 034 00	10	1	38	10	1	18	10	5	20	10	1	04	13	2	27	11	1
01	10	1	41	10	1	20	10	1	21	10	1	05	13	1	28	11	1
02	10	1	43	10	1	23	10	1	22	10	1	06	13	1	29	11	1
03	10	1	44	10	1	24	10	1	23	10	1	07	13	10	30	11	1
04	10	1	45	10	1	25	10	1	24	10	1	10	13	1	64	11	1
05	10	1	46	10	1	26	10	1	25	10	1	11	13	1	65	11	1
06	10	1	47	10	1	27	10	1	26	10	1	12	13	1	66	11	1
07	10	1	48	10	1	28	10	1	27	10	1	13	13	3	67	11	1
08	10	1	49	10	1	29	10	1	28	10	1	19	13	1	74	11	1
10	10	1	50	10	1	30	10	1	49	10	1	20	13	1	75	11	1
13	10	1	51	10	1	31	10	1	52	10	1	4 115 00			76	11	1
15	10	1	55	10	1	32	10	1	54	10	1	4 115 02	11	1	77	11	1
16	10	1	58	10	1	48	10	1	55	10	1	09	11	1	84	11	1
17	10	1	60	10	1	51	10	1	56	10	1	10	11	1	85	11	1
18	10	1	61	10	1	52	10	1	57	10	1	11	11	1	86	11	1
			62	10	1	53	10	1	58	10	1	12	11	1	87	11	1
			63	10	1	54	10	1	59	10	1	19	11	1			
			64	10	1	55	10	1	60	10	1	20	11	1			
			65	10	1	56	10	1	61	10	1						
			66	10	1	57	10	1	62	10	1						



FOLLOW
US ON

@ www.legrand.com

 www.youtube.com/legrand

 twitter.com/legrand_news



Head office

and International Department
87045 Limoges Cedex - France

Tel.: + 33 (0) 5 55 06 87 87

Fax: + 33 (0) 5 55 06 74 55